

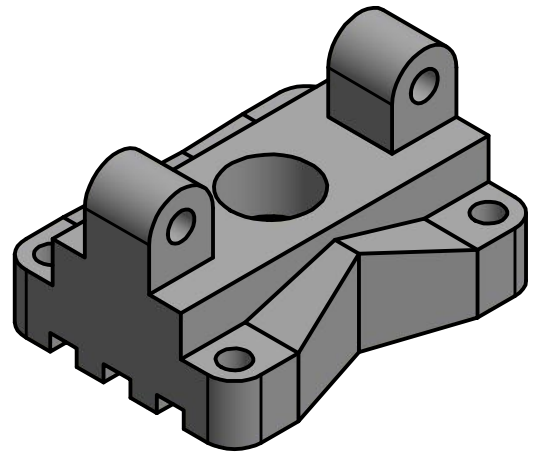

A-A (1 : 2)

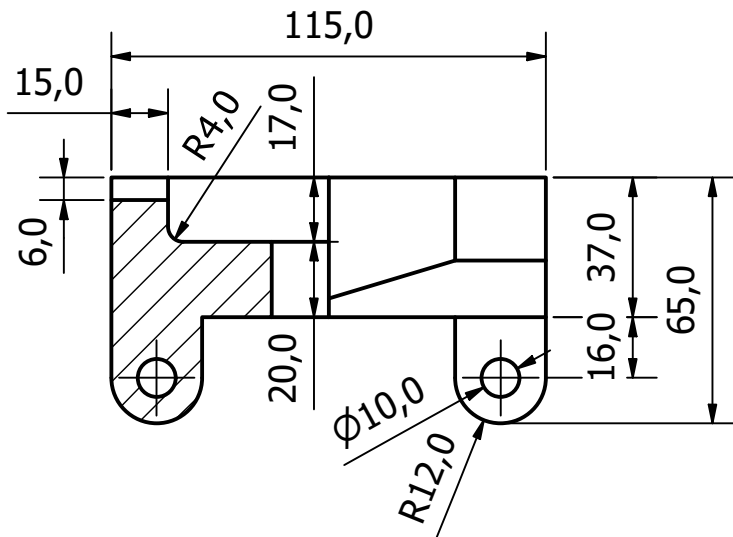

Desenhado por: Mateus Muller Barbieri	Checado por: Ricardo Pedro Bom	Modificado de: PROTEC	Data: 08/03/2017
 UDESC UNIVERSIDADE DO ESTADO DE SANTA CATARINA		Peça 12	
Detalhamento da Peça 12		Escala 1:2	Folha 12/13