

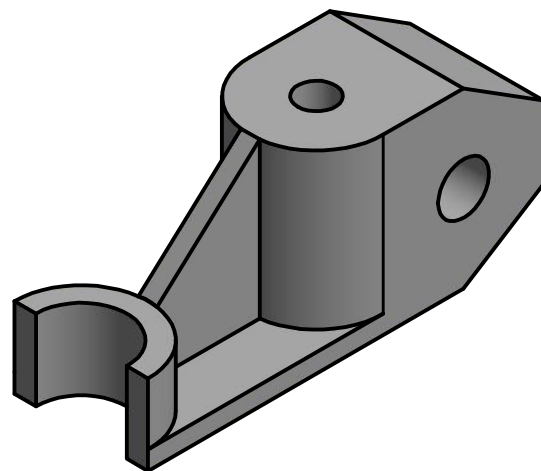

A-A (1 : 2)

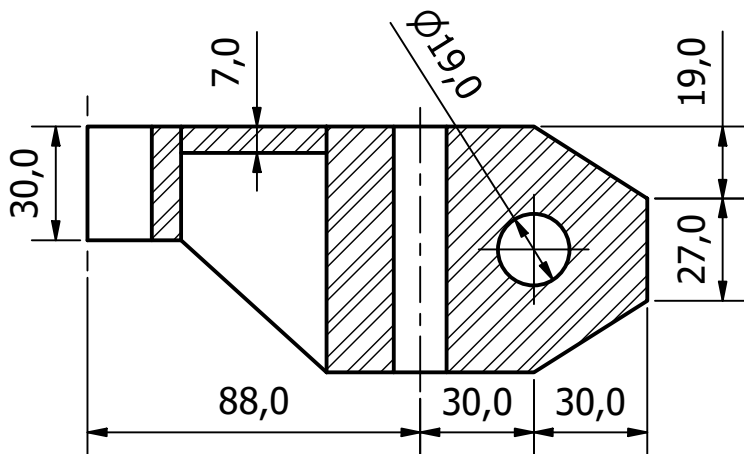

Desenhado por: Mateus Muller Barbieri	Checado por: Ricardo Pedro Bom	Modificado de: PROTEC	Data: 02/03/2017
 <b>UDESC</b> UNIVERSIDADE DO ESTADO DE SANTA CATARINA		Peça 5	
Detalhamento da Peça 5		Escala 1:2	Folha 5/13