

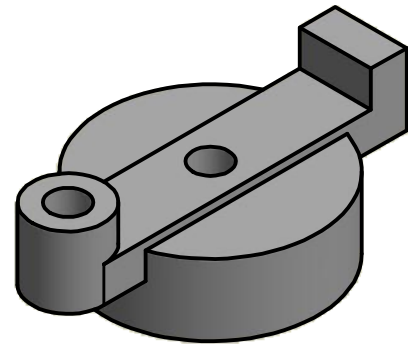

A-A (1 : 3)

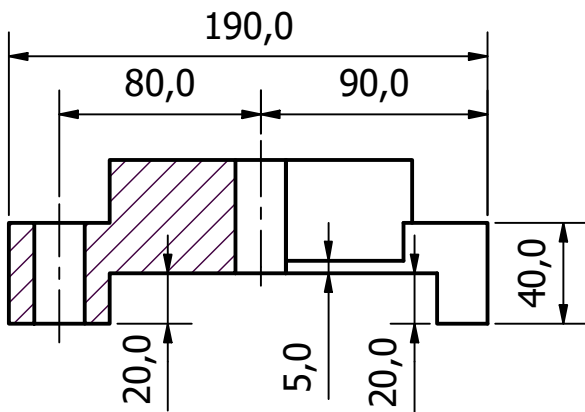

Desenhado por: Mateus Muller Barbieri	Checado por: Ricardo Pedro Bom	Modificado de: PROTEC	Data: 06/03/2017
 UDESC UNIVERSIDADE DO ESTADO DE SANTA CATARINA		Peça 6	
Detalhamento da Peça 6		Escala 1:3	Folha 6/13